

HD31



- Three independent input channels
- Automatic recognition of the probes
- Colour graphic display
- Graph display of the measures
- Configurable measuring unit
- Data logging function with programming of auto start and auto stop
- Data storing on SD card for long logging duration
- Automatic creation of pdf reports
- Functions: HOLD, REL (relative measure) and DIFF (difference)
- Detection of minimum, average and maximum value
- Password protected configuration
- USB connection to PC
- Serial output for printer
- Rechargeable Battery
- Auto power off (configurable and excludable)

Description

HD31 is a handheld portable multifunction meter and data logger, with a large (43 x 58 mm) graphic color LCD display.

It is equipped with three independent inputs. Each input can be connected to SICRAM probes (intelligent and interchangeable probes with calibration data stored inside the module), both single and combined, for the measurement of a plurality of physical quantities:

- Temperature
- Relative humidity
- Atmospheric and differential pressure
- Air speed
- Illuminance (lux) and Irradiance
- Carbon dioxide (CO₂) – Air Quality
- Direct voltage (VP473 module) and current (IP472 module)

The type of sensor connected to the various inputs is automatically recognized by the instrument.

By connecting a combined temperature and relative humidity probe, the instrument calculates the quantities derived from humidity: dew point temperature, wet bulb temperature, absolute humidity, mixing ratio, partial vapor pressure, saturated vapor pressure, enthalpy. Moreover, the DI discomfort index and the NET (Net Effective Temperature) index are calculated.

It is also possible to connect not SICRAM probes to the instrument's inputs by using special interface modules to be inserted between the instrument and the probe.

Simultaneous display of three variables in numerical form. Real time visualization on display of the graph of a measured variable.

Measurement units selectable according to the measured physical quantity.

Data logging function with data storing in CSV format directly to the SD type memory card, for a long duration of the logging (for example, with a 4GB SD card, the duration of the logging is in the order of months, even when recording many quantities with the minimum logging interval equal to 1 second). Storage interval configurable by the user. Automatic or manual start and stop of the logging. Storing of date and time of each recorded sample. Automatic creation of measurement reports in PDF format on the memory card.

Manual (it captures the current measurement at simply pushing a key) or automatic (it acquires the current measurement once per second) RECORD function for the calculation of minimum, medium and maximum values measured.

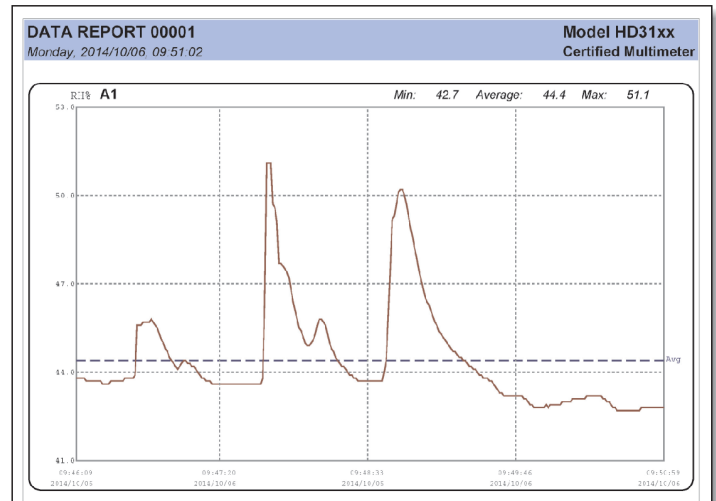

DATA REPORT 00001
Monday, 2014/10/06, 09:51:02

Model HD31xx
Certified Multimeter

#	Date	Time	A1 Rel.Humidity RH%	A2 Temperature °C	A3 Diff.Pressure Pa	#	Date	Time	A1 Rel.Humidity RH%	A2 Temperature °C	A3 Diff.Pressure Pa
00001	2014/10/06	09:46:09	43.6	25.20	32.08	00059	2014/10/06	09:47:17	43.6	25.33	32.50
00002	2014/10/06	09:46:10	43.6	25.20	32.08	00070	2014/10/06	09:47:18	43.6	25.33	32.50
00003	2014/10/06	09:46:11	43.6	25.20	32.08	00071	2014/10/06	09:47:19	43.6	25.33	32.50
00004	2014/10/06	09:46:12	44.8	25.20	32.08	00072	2014/10/06	09:47:20	43.6	25.33	32.50
00005	2014/10/06	09:46:13	43.6	25.29	32.06	00073	2014/10/06	09:47:21	43.6	25.33	32.50
00006	2014/10/06	09:46:14	43.7	25.29	32.06	00074	2014/10/06	09:47:22	43.6	25.33	32.50
00007	2014/10/06	09:46:15	43.7	25.29	32.06	00075	2014/10/06	09:47:23	43.6	25.33	32.50
00008	2014/10/06	09:46:16	43.7	25.29	32.06	00076	2014/10/06	09:47:24	43.6	25.30	32.28
00009	2014/10/06	09:46:17	43.7	25.20	32.08	00077	2014/10/06	09:47:25	43.6	25.30	32.28
00010	2014/10/06	09:46:18	43.7	25.20	32.08	00078	2014/10/06	09:47:26	43.6	25.30	32.28
00011	2014/10/06	09:46:19	43.7	25.29	32.06	00079	2014/10/06	09:47:27	43.6	25.30	32.28
00012	2014/10/06	09:46:20	43.7	25.29	32.06	00080	2014/10/06	09:47:28	43.6	25.30	32.28
00013	2014/10/06	09:46:21	43.7	25.29	32.06	00081	2014/10/06	09:47:29	43.6	25.33	32.50
00014	2014/10/06	09:46:22	44.6	25.28	32.04	00082	2014/10/06	09:47:30	43.6	25.30	32.28
00015	2014/10/06	09:46:23	43.6	25.29	32.06	00083	2014/10/06	09:47:31	43.6	25.33	32.50
00016	2014/10/06	09:46:24	43.6	25.29	32.06	00084	2014/10/06	09:47:32	43.6	25.33	32.50
00017	2014/10/06	09:46:25	43.6	25.29	32.06	00085	2014/10/06	09:47:33	43.6	25.30	32.28
00018	2014/10/06	09:46:26	43.7	25.28	32.04	00086	2014/10/06	09:47:34	43.6	25.30	32.28
00019	2014/10/06	09:46:27	43.7	25.28	32.04	00087	2014/10/06	09:47:35	43.6	25.33	32.50
00020	2014/10/06	09:46:28	43.7	25.29	32.06	00088	2014/10/06	09:47:36	43.6	25.33	32.50
00021	2014/10/06	09:46:29	43.7	25.29	32.06	00089	2014/10/06	09:47:37	43.6	25.32	32.50
00022	2014/10/06	09:46:30	43.7	25.29	32.06	00090	2014/10/06	09:47:38	43.6	25.32	32.50
00023	2014/10/06	09:46:31	43.7	25.20	32.08	00091	2014/10/06	09:47:39	43.6	25.32	32.50
00024	2014/10/06	09:46:32	43.7	25.20	32.08	00092	2014/10/06	09:47:40	43.6	25.32	32.50
00025	2014/10/06	09:46:33	43.6	25.29	32.06	00093	2014/10/06	09:47:41	43.8	25.33	32.53
00026	2014/10/06	09:46:34	43.8	25.29	32.06	00094	2014/10/06	09:47:42	46.4	25.34	32.55
00027	2014/10/06	09:46:35	43.6	25.29	32.06	00095	2014/10/06	09:47:43	51.1	25.36	32.59
00028	2014/10/06	09:46:36	43.6	25.20	32.08	00096	2014/10/06	09:47:44	51.1	25.40	32.47
00029	2014/10/06	09:46:37	43.6	25.20	32.08	00097	2014/10/06	09:47:45	51.1	25.47	32.61
00030	2014/10/06	09:46:38	43.9	25.21	32.10	00098	2014/10/06	09:47:46	49.7	25.51	32.68
00031	2014/10/06	09:46:39	45.6	25.22	32.12	00099	2014/10/06	09:47:47	49.6	25.53	32.72
00032	2014/10/06	09:46:40	45.6	25.24	32.16	00100	2014/10/06	09:47:48	49.1	25.53	32.72
00033	2014/10/06	09:46:41	45.6	25.28	32.24	00101	2014/10/06	09:47:49	47.7	25.43	32.72
00034	2014/10/06	09:46:42	45.7	25.30	32.28	00102	2014/10/06	09:47:50	47.7	25.50	32.70

Report in PDF format with graphs and tables

HOLD function (it freezes the current measurements on display), REL function (difference compared to a stored value) and DIFF function (difference between two homogeneous measures, for example between the measures of two temperature probes).

Password protected functions. A 'Quick Help' on the display helps using the instrument functions.

The USB port with mini USB connector for PC connection is meant for configuration and download of the acquired data. The **DeltaLog9** application software is downloadable from Delta OHM website. The USB port can operate in "HID" (Human Interface Device) or "Virtual COM" mode. The "HID" mode has the advantage of not requiring the installation of USB drivers: when the instrument is connected to the PC, the Windows® operating system recognizes the instrument automatically and uses the drivers that are already included in the operating system. The "Virtual COM" mode allows communicating with the instrument by sending commands via a generic serial communication program.

It has the MSD (Mass Storage Device) under which the instrument is considered by the PC an SD card reader, thus allowing direct access to the memory card to view, copy or delete the recorded files.

Serial output for printing the visualized measures on a printer with RS232C input. Baud Rate adjustable from 1200 to 115200.

HD31

sn 14020975

A SICRAM RH-Pt100

sn 09002559

cal factory

B SICRAM Pt100

sn 20130002

cal factory

C SICRAM Pt100

sn 20130003

cal factory

2016-04-15 16:33:31

A1 50.9 RH%

B1 23.89 °C

C1 24.61 °C

Example of the measurement print out



Rechargeable lithium-ion battery. Auto power off (excludable) after an idle time configurable by the user (2, 5, 10, 15, 20 or 30 minutes) to preserve the battery charge. External power supply through USB port (with mini-USB connector) by connecting a 5 Vdc adapter or the USB port (at least 500 mA) of a PC. With external power supply connected, the battery is recharged and the auto power off is automatically deactivated.

The probes are factory calibrated and interchangeable. Calibration reports or certificates are available upon request.

A strong and protective rubber housing, provided with a removable back support, is available as **option**.

Instrument description

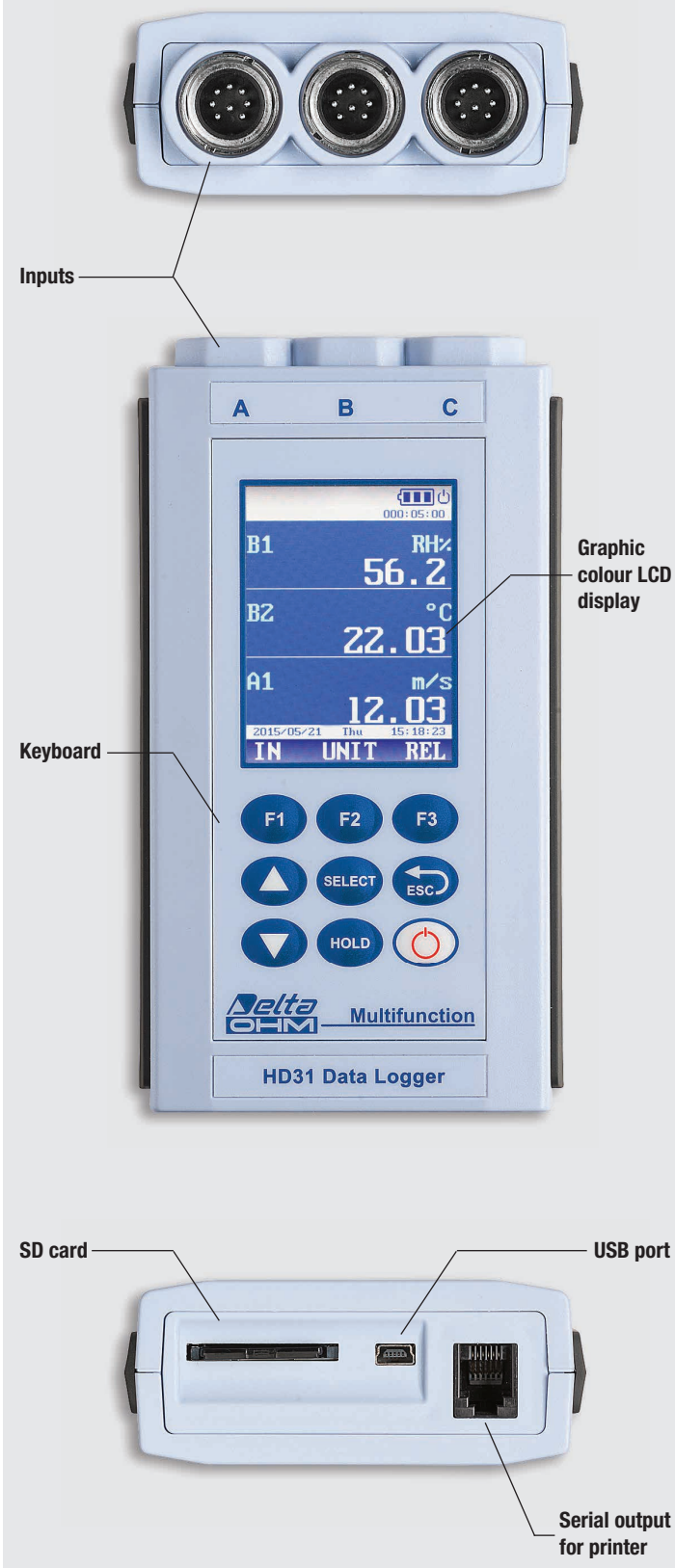

Technical characteristics

Power supply	Rechargeable internal 3.7 V Lithium battery, capacity 2250 mA/h, JST 3-pole connector. Optional external 5 Vdc/1A power supply (SWD05) to be connected at the mini-USB connector of the instrument. Powered by the PC USB port (at least 500 mA) when connected to the PC.
Battery autonomy	18 hours of continuous operation (typical autonomy with full charge battery and three connected Pt100 probes). The effective autonomy depends on the number and type of connected sensors.
Logging interval	1, 5, 10, 15, 30 seconds / 1, 2, 5, 10, 15, 20, 30 minutes / 1 hour
Storage capacity	SD memory card with capacity up to 4 GB. The logging duration depends on the number of logged quantities and on the capacity of the SD card employed. For example: with a 4GB SD card the duration of the logging is in the order of months, even when many quantities are recorded with the minimum logging interval equal to 1 s.
Inputs	3 8-pole DIN45326 connector inputs. Depending on the type of connected probes, the instrument manages up to 36 quantities.
Accuracy @ 20°C	± 0.02 % of the measure (the instrument only, excluded the accuracy of the probes connected)
Temperature drift @ 20°C	20 ppm/°C (the instrument only, excluded the drift of the probes connected)
Long term stability	0.05 %/year (the instrument only, excluded the stability of the probes connected)
Clock stability	1 min/month maximum drift
Display	Color graphic LCD. Visible area 43 x 58 mm.
USB Connection	1 USB port with mini USB connector.
RS232C Connection	1 serial RS232C output with RJ12 (6P6C) connector for connecting to a serial printer. Baud Rate selectable from 1200 to 115200.
Auto power off	Configurable after 2, 5, 10, 15, 20 or 30 minutes from last pressure of a key, with battery supply. It can be disabled. Automatically disabled when powered from external supply.
Operating conditions	-10 ... 60 °C, 0 ... 85% RH without condensation.
Storage temperature	-25 ... 65 °C
Materials	ABS, protective 55 shore rubber bands on the sides. 55 shore rubber protective shell.
Dimensions	165x88x35 mm without rubber protection shell 180x102x46 mm with rubber protection shell
Weight	About 400 g. (including batteries and protection shell)
Protection degree	IP 64

The accuracy and resolution characteristics of the instrument in line with the available SICRAM modules are detailed in the descriptive sections of the modules themselves.

Protection shell with support



LCD description

Status bar

Measures

Date / hour

Functions

Real time measurement graph

HELP functions on the display

Software DeltaLog 9

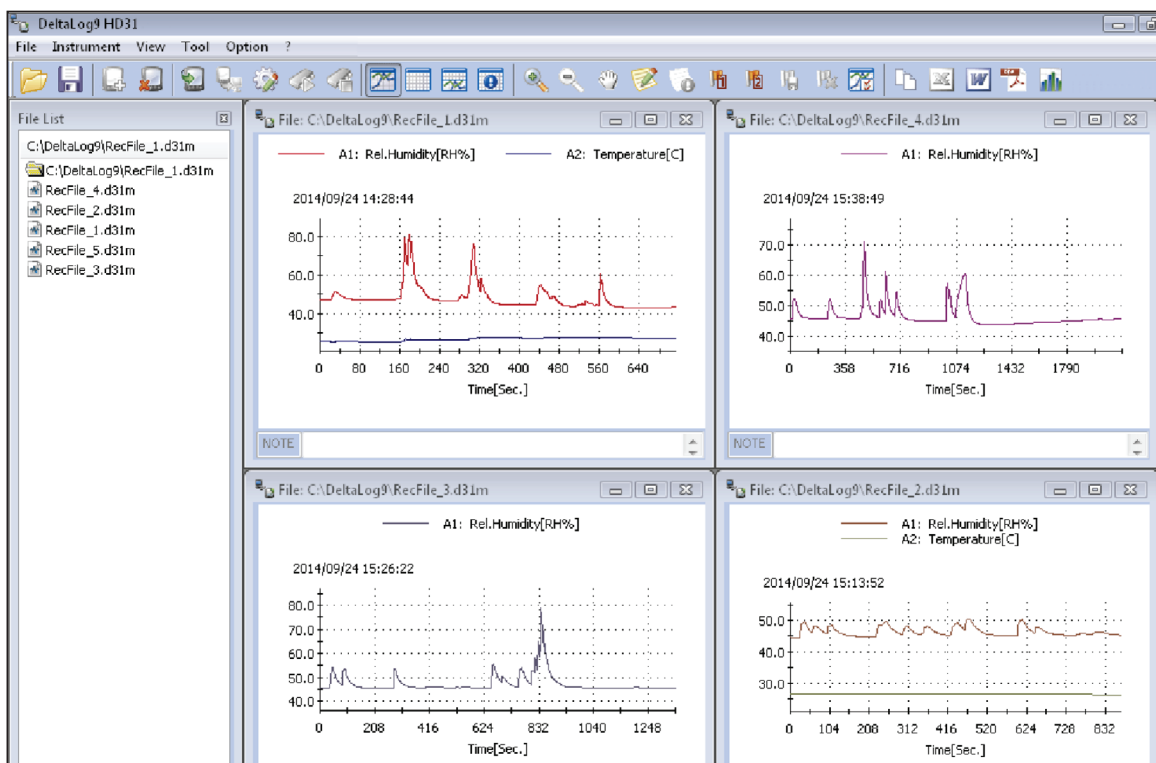

TECHNICAL DATA OF SICRAM PROBES AND MODULES IN LINE WITH THE INSTRUMENTS

Direct voltage and current

VP473 SICRAM module for the measurement of direct voltage. When connected to a transmitter with voltage output, it can acquire the voltage signal. Measuring range: ± 20 Vdc. Input impedance: 1 M Ω .

IP472 SICRAM module for the measurement of direct current. When connected to a transmitter with current output, it can acquire the current signal. Measuring range: 0...24 mA. Input impedance: 25 Ω .

Temperature with Platinum sensors (PRT)

4-wire Pt100 sensor temperature probes equipped with SICRAM module

Model	Type	Application range	Accuracy
TP472I	Immersion	-196 °C...+500 °C	± 0.25 °C (-196 °C...+300 °C) ± 0.5 °C (+300 °C...+500 °C)
TP472I.0 1/3 DIN - Thin Film	Immersion	-50 °C...+300 °C	± 0.25 °C
TP473P.I	Penetration	-50 °C...+400 °C	± 0.25 °C (-50 °C...+300 °C) ± 0.5 °C (+300 °C...+400 °C)
TP473P.0 1/3 DIN - Thin Film	Penetration	-50 °C...+300 °C	± 0.25 °C
TP474C.0 1/3 DIN - Thin Film	Contact	-50 °C...+300 °C	± 0.3 °C
TP475A.0 1/3 DIN - Thin Film	Air	-50 °C...+250 °C	± 0.3 °C
TP472I.5	Immersion	-50 °C...+400 °C	± 0.3 °C (-50 °C...+300 °C) ± 0.6 °C (+300 °C...+400 °C)
TP472I.10	Immersion	-50 °C...+400 °C	± 0.3 °C (-50 °C...+300 °C) ± 0.6 °C (+300 °C...+400 °C)
TP49A.I	Immersion	-70 °C...+250 °C	± 0.25 °C
TP49AC.I	Contact	-70 °C...+250 °C	± 0.25 °C
TP49AP.I	Penetration	-70 °C...+250 °C	± 0.25 °C
TP875.I	Globe-thermometer \varnothing 150 mm	-30 °C...+120 °C	± 0.25 °C
TP876.I	Globe-thermometer \varnothing 50 mm	-30 °C...+120 °C	± 0.25 °C
TP87.0 1/3 DIN - Thin Film	Immersion	-50 °C...+200 °C	± 0.25 °C
TP878.0 1/3 DIN - Thin Film	Photovoltaic	-40 °C...+85 °C	± 0.25 °C
TP878.1.0 1/3 DIN - Thin Film	Photovoltaic	-40 °C...+85 °C	± 0.25 °C
TP879.0 1/3 DIN - Thin Film	Compost	-20 °C...+120 °C	± 0.25 °C

Common characteristics

Resolution

0.01 °C from -200 °C to 350 °C / 0.1 °C from 350 °C to 800 °C

Temperature drift @ 20 °C

0.003 %/°C

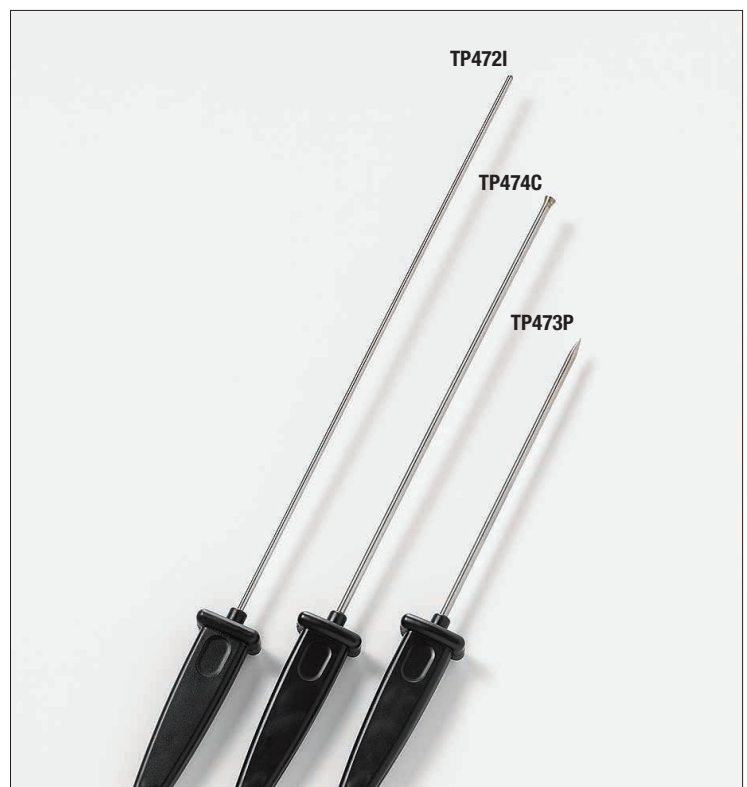

4-wire Pt100 and 2-wire Pt1000 probes

Model	Type	Application range	Accuracy
TP47.100.0 1/3 DIN – Thin Film	4-wire Pt100	-50...+250 °C	1/3 DIN
TP47.1000.0 1/3 DIN – Thin Film	2-wire Pt1000	-50...+250 °C	1/3 DIN
TP87.100.0 1/3 DIN – Thin Film	4-wire Pt100	-50...+200 °C	1/3 DIN
TP87.1000.0 1/3 DIN – Thin Film	2-wire Pt1000	-50...+200 °C	1/3 DIN

Common characteristics

Resolution 0.01 °C from -200 °C to 350 °C / 0.1 °C from 350 °C to 800 °C

Temperature drift @ 20 °C

Pt100	0.003 %/°C
Pt1000	0.005 %/°C

TP471	Module for NO SICRAM temperature probes with Platinum sensor (PRT).
Resistance values of the sensor @ 0 °C	25 Ω, 100 Ω, 500 Ω
Measuring range Pt25, Pt100	-200 °C ... +850 °C
Measuring range Pt500	-200 °C ... +500 °C
Accuracy with Pt25, Pt100 sensor	±0.03 °C up to 350 °C ±0.3 °C up to 850 °C
Accuracy with Pt500 sensor	±0.5 °C up to 500 °C
Resolution	0.01 °C from -200 °C to 350 °C 0.1 °C from 350 °C to 800 °C
Temperature drift @ 20 °C	0.002 %/°C
Excitation current	400 μA impulsive, Duration=100 ms, Period=1 s

Temperature with thermocouple sensors

TP471D0 1-input module for **NO** SICRAM probes with thermocouple sensors type K-J-E-T-N-R-S-B. **Without cold joint compensation.**

TP471D 1-input module for **NO** SICRAM probes with thermocouple sensors type K-J-E-T-N-R-S-B. **With internal sensor for cold joint compensation.**

TP471D1 2-input module for **NO** SICRAM probes with thermocouple sensors type K-J-E-T-N-R-S-B. **With internal sensor for cold joint compensation.**

Characteristics of thermocouple temperature measurement (modules TP471D0, TP471D, TP471D1)

Measuring range Tc: K	-200 ... +1370 °C
Measuring range Tc: J	-100 ... +750 °C
Measuring range Tc: T	-200 ... +400 °C
Measuring range Tc: N	-200 ... +1300 °C
Measuring range Tc: R	+200 ... +1480 °C
Measuring range Tc: S	+200 ... +1480 °C
Measuring range Tc: B	+200 ... +1800 °C
Measuring range Tc: E	-200 ... +750 °C

Resolution 0.05 °C up to 199.95 °C
0.1 °C from 200.0 °C till full scale

Instrument accuracy:	
Thermocouple K	±0.1 °C up to 600 °C ±0.2 °C above 600 °C
Thermocouple J	±0.05 °C up to 400 °C ±0.1 °C above 400 °C
Thermocouple T	±0.1 °C
Thermocouple N	±0.1 °C up to 600 °C ±0.2 °C above 600 °C
Thermocouple R	±0.25 °C
Thermocouple S	±0.3 °C
Thermocouple B	±0.35 °C
Thermocouple E	±0.1 °C up to 300 °C ±0.15 °C above 300 °C

The accuracy is referred to the instrument only, the error due to the thermocouple or the cold joint reference sensor is excluded.

Temperature drift @ 20 °C	0.02 %/°C
Drift after 1 year	0.1 °C/year

Tolerance of the thermocouple probes:

The tolerance of a type of thermocouple corresponds to the maximum allowed deviation from the e.m.f. of any thermocouple of that type, with reference junction at 0°C. The tolerance is expressed in Celsius degrees, preceded by the sign. The tolerances refer to the operating temperature for which the thermocouple is provided, depending on the diameter of the thermo elements.

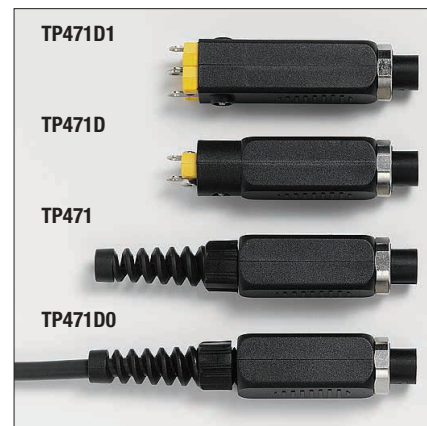

THERMOCOUPLE TOLERANCE CLASSES

Tolerances according to the standard IEC 60584-2.

The values are referred to thermocouples with reference junction at 0 °C.

Type of thermo-couple	Class 1 tolerance		Class 2 tolerance		Class 3 tolerance	
	Temperature interval (°C)	Tolerance (°C)	Temperature interval (°C)	Tolerance (°C)	Temperature interval (°C)	Tolerance (°C)
B	---	---	+600...+1700	$\pm 0.0025 \times t$	+600...+800	± 4
	---	---	---	---	+800...+1700	$\pm 0.005 \times t$
E	-40...+375	± 1.5	-40...+333	± 2.5	-167...+40	± 2.5
	+375...+800	$\pm 0.004 \times t$	+333...+900	$\pm 0.0075 \times t$	-200...-167	$\pm 0.015 \times t$
J	-40...+375	± 1.5	-40...+333	± 2.5	---	---
	+375...+750	$\pm 0.004 \times t$	+333...+750	$\pm 0.0075 \times t$	---	---
K, N	-40...+375	± 1.5	-40...+333	± 2.5	-167...+40	± 2.5
	+375...+1000	$\pm 0.004 \times t$	+333...+1200	$\pm 0.0075 \times t$	-200...-167	$\pm 0.015 \times t$
R, S	0...+1100	± 1	0...+600	± 1.5	---	---
	+1100...+1600	$\pm [1+0.003 \times (t-1100)]$	+600...+1600	$\pm 0.0025 \times t$	---	---
T	-40...+125	± 0.5	-40...+133	± 1	-67...+40	± 1
	+125...+350	$\pm 0.004 \times t$	+133...+350	$\pm 0.0075 \times t$	-200...-67	$\pm 0.015 \times t$







Note: t = temperature of the measuring junction in °C.

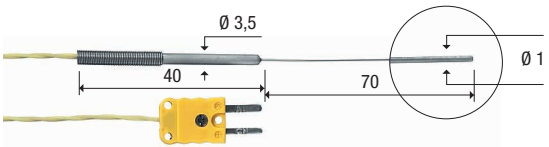
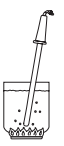
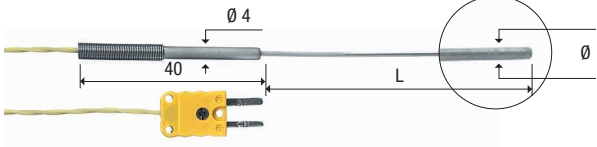
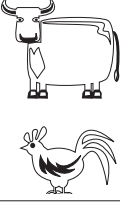

THERMOCOUPLE PROBES TYPE "K" (CHROMEL - ALUMEL) WITH GROUNDED HOT JUNCTION

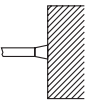
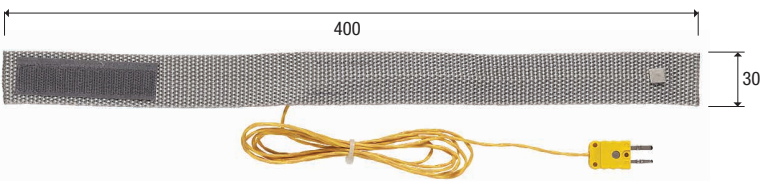
CODE	°C max	τ s	DIMENSIONS (mm)		USE
TP741	800	2s	L=180	$\varnothing=1.5$	
TP741/1	400	2s	L=90	$\varnothing=1.5$	
TP741/2	800	2s	L=230	$\varnothing=1.5$	
TP742	800	2s	L=180	$\varnothing=2$	
TP742/1	400	2s	L=90	$\varnothing=2$	
TP742/2	800	2s	L=230	$\varnothing=2$	
TP743	800	3s	L=180	$\varnothing=3$	
TP744	400	4s			
TP745	500	5s			
TP746	250	2s			
TP750	-196 +1000	3s	L=500	$\varnothing=3$	
TP750.0	-196 +800	3s	L=300	$\varnothing=3$	
TP751	200	2s			
	500	2s			
TP754/9	500	2s			
TP754					
TP755	800	2s			
TP755/9	800	2s			

THERMOCOUPLE PROBES TYPE "K" (CHROMEL - ALUMEL) WITH GROUNDED HOT JUNCTION					
CODE	°C max	τ s	DIMENSIONS (mm)		USE
TP756	200	2s			
TP757	180	30s	MAGNETIC PROBE FOR CONTACT MEASUREMENTS ON MAGNETIC METALLIC SURFACES 		
TP758	400	4s	L=150	$\varnothing=4$	
TP758.1	400	4s	L=90	$\varnothing=4$	
TP772	400	3s			
TP774	250	2s			
TP776	200	2s			
TP777	200	3s			
TP647	300	2s	ACCREDIA calibration up to max. 300°C. 		
TP647/2	300	2s			
TP647/3	300	2s			
TP647/5	300	2s			
TP647/10	300	2s			
TP647/20	300	2s			
TP651	1200	6s	L=1200	$\varnothing=6$	
TP652	1200	6s	L=700	$\varnothing=6$	
TP655	180	2s			

THERMOCOUPLE PROBES TYPE "K" (CHROMEL - ALUMEL) WITH GROUNDED HOT JUNCTION						
CODE	°C max	τ s	DIMENSIONS (mm)			USE
TP656	200	1s	L=70	$\varnothing=1$		
TP656/1	1000	1s	L=500	$\varnothing=2$		
TP656/2	1000	1s	L=1000	$\varnothing=2$		
TP657/1	100	5s			 <p>Flexible</p>	
TP659	400	3s	L=150	$\varnothing=3$		
TP660	400	4s	L=150	$\varnothing=4.5$		
TP661	-60 +50	30s				
TP662	110	120s			<p>TAPE PROBES WITH VELCRO FOR MEASUREMENTS ON PIPES MAX DIAM. 110</p>  <p>Certification up to 58°C</p>	
CM CS	"K" "K"					
PW	"K"					

Response time for a 63% variation ($\tau_{0.63}$)

The response time τ_s is the response time of the sensor to a temperature variation, with a corresponding variation of the measured signal to a given percentage (63%) of the variation.

Response time is referred:

- Immersion probes in water at 100 °C
- Surface probes in contact with metals surface at 200 °C
- Air probes in air temperature at 100 °C

Relative humidity and temperature

Relative humidity and temperature probes equipped with SICRAM module

Model	Temperature sensor	Application range		Accuracy	
		%RH	Temperature	%RH	Temp
HP472ACR	Pt100	0...100%RH	-20 °C...+80 °C	±1.5% (0...85%RH)	±0.3 °C
HP473ACR	Pt100	0...100%RH	-20 °C...+80 °C		±0.3 °C
HP474ACR	Pt100	0...100%RH	-40 °C...+150 °C	±2.5% (85...100%RH) @ T=15...35 °C	±0.3 °C
HP475ACR	Pt100	0...100%RH	-40 °C...+150 °C	(2 + 1.5% measure)% @ T= remaining field	±0.3 °C
HP475AC1R	Pt100	0...100%RH	-40 °C...+180 °C		±0.3 °C
HP477DCR	Pt100	0...100%RH	-40 °C...+100 °C	±0.3 °C	±0.3 °C
HP478ACR	Pt100	0...100%RH	-40 °C...+150 °C		±0.3 °C
HP480	Pt100	0...100%RH	-40 °C...+60 °C		±0.25 °C
HP481	Pt100	0...100%RH	-40 °C...+60 °C		±0.25 °C

Common characteristics

Relative Humidity

Sensor	Capacitive
Resolution	0.1%RH
Temperature drift @ 20 °C	0.02 %RH/°C
Response time %RH at constant temperature	10 s (10→80 %RH; air speed=2 m/s)

Temperature with Pt100 sensor

Resolution	0.1 °C
Temperature drift @ 20 °C	0.01 °C for HD31 0.003 %/°C



Protections and solutions for relative humidity and temperature probes

- P1** 200µm stainless steel grid protection for probes Ø26, thread M24x1.5. For temperatures up to 80 °C.
- P2** 20µm PE sintered polythene protection for probes Ø26, thread M24x1.5. For temperatures up to 80 °C.
- P3** 20µm sintered bronze protection for probes Ø26, thread M24x1.5. For temperatures up to 150 °C.
- P4** 20µm sintered PE complete cap for probes Ø26, thread M24x1.5. For temperatures up to 80 °C.



- P6** 10µm sintered stainless steel protection for probes Ø14, thread M12x1. For temperatures up to 180 °C.
- P7** 20µm PTFE protection for probes Ø14, thread M12x1. For temperatures up to 150 °C.
- P8** 20µm stainless steel grid and PBT protection for probes Ø14, thread M12x1. For temperatures up to 100 °C.
- HD75** 75% RH saturated solution for checking the relative humidity sensor, complete with screw adaptor for probes Ø14, M12×1 thread.
- HD33** 33% RH saturated solution for checking the relative humidity sensor, complete with screw adaptor for probes Ø14, M12×1 thread.

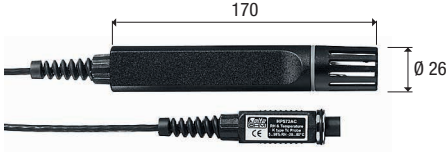
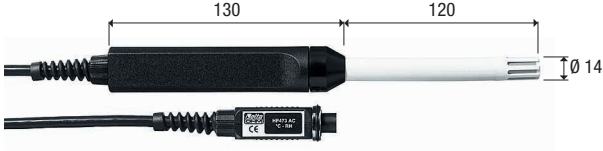
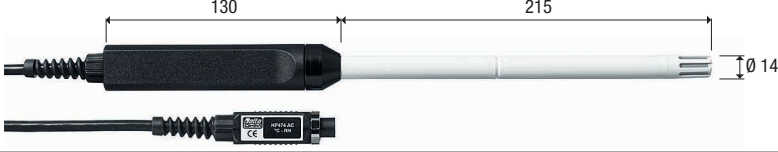
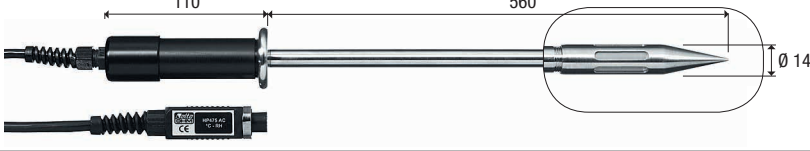
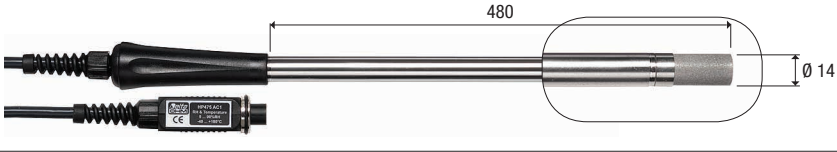
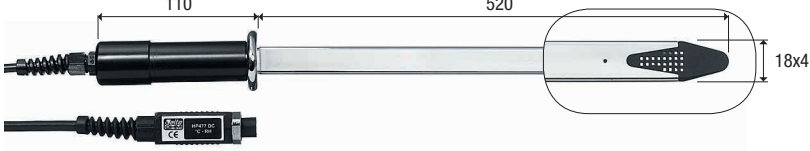
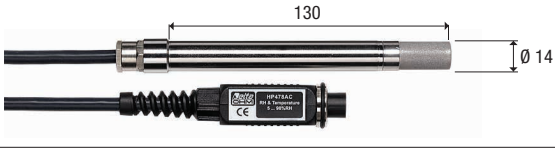

RELATIVE HUMIDITY AND TEMPERATURE PROBES

COD.	Sensors	Range RH - Temp.	USE
HP472ACR	RH Pt100	0...100% RH -20°C...+80°C	
HP572ACR	RH TC.K		
HP473ACR			
HP474ACR		0...100% RH -40°C...+150°C (-40°C...+180°C for HP475AC1R)	
HP475ACR	RH Pt100		
HP475AC1R			
HP477DCR			
HP478ACR			
HP480 HP481	RH Pt100	0...100% RH -40°C...+60°C	

SATURATED SOLUTIONS AND PROBE PROTECTIONS

COD.			USE
HD75 HD33 HD11		Threaded ring nut M24 x 1.5 for probes Ø 26 Threaded ring nut M12 x 1 for probes Ø 14	
P1 P2 P3 P4	Ø 26	M 24x1.5	
P6 P7 P8	Ø 14	M 12x1	

Pressure

PP471 SICRAM module for the measurement of absolute, relative and differential pressure. It works with pressure probes of the series TP704 and TP705. It gives the instantaneous value and the peak of the pressure. The module is supplied with cable L=2m and 8-pole female DIN 45326 connector.

Accuracy	±0.05% of the full scale (f.s.)
Duration of the peak	≥ 5 ms
Accuracy of peak	±0.5% f.s.
Dead band of peak	≤ 2% f.s.

Pressure probes of the series TP704 and TP705 to be connected to the PP471 module

Full scale pressure	Maximum over-pressure	Resolution	ORDERING CODES			Accuracy from 20 to 25°C	Working temperature	Connection
			Differential pressure	Relative pressure (with respect to atmosphere)	Absolute pressure			
			NON insulated Membrane	Insulated membrane	Insulated membrane			
10.0 mbar	20.0 mbar	0.01 mbar	TP705-10MBD			0.50 % FSO	0...+60 °C	Tube Ø 5 mm
20.0 mbar	40.0 mbar	0.01 mbar	TP705-20MBD			0.50 % FSO	0...+60 °C	Tube Ø 5 mm
50.0 mbar	100 mbar	0.01 mbar	TP705-50MBD			0.50 % FSO	0...+60 °C	Tube Ø 5 mm
100 mbar	200 mbar	0.1 mbar	TP705-100MBD			0.25 % FSO	0...+60 °C	Tube Ø 5 mm
				TP704-100MBGI		0.25 % FSO	-10...+80 °C	¼ BSP
200 mbar	400 mbar	0.1 mbar	TP705-200MBD			0.25 % FSO	0...+60 °C	Tube Ø 5 mm
				TP704-200MBGI		0.25 % FSO	-10...+80 °C	¼ BSP
400 mbar	1000 mbar	0.1 mbar		TP704-400MBGI		0.25 % FSO	-40...+125 °C	¼ BSP
500 mbar	1000 mbar	0.1 mbar	TP705-500MBD			0.25 % FSO	0...+60 °C	Tube Ø 5 mm
600 mbar	1000 mbar	0.1 mbar		TP704-600MBGI		0.25 % FSO	-40...+125 °C	¼ BSP
1.00 bar	2.00 bar	1 mbar	TP705-1BD			0.25 % FSO	0...+60 °C	Tube Ø 5 mm
					TP705BARO	0.25 % FSO	0...+60 °C	Tube Ø 5 mm
				TP704-1BGI		0.25 % FSO	-40...+125 °C	¼ BSP
2.00 bar	4.00 bar	1 mbar			TP704-1BAI	0.25 % FSO	-40...+120 °C	¼ BSP
			TP705-2BD			0.25 % FSO	0...+60 °C	Tube Ø 5 mm
				TP704-2BGI		0.25 % FSO	-40...+125 °C	¼ BSP
5.00 bar	10.00 bar	1 mbar			TP704-2BAI	0.25 % FSO	-25...+85 °C	¼ BSP
				TP704-5BGI		0.25 % FSO	-40...+125 °C	¼ BSP
					TP704-5BAI	0.25 % FSO	-25...+85 °C	¼ BSP
10.0 bar	20.0 bar	0.01 bar		TP704-10BGI		0.25 % FSO	-40...+125 °C	¼ BSP
					TP704-10BAI	0.25 % FSO	-25...+85 °C	¼ BSP
20.0 bar	40.0 bar	0.01 bar		TP704-20BGI		0.25 % FSO	-40...+125 °C	¼ BSP
					TP704-20BAI	0.25 % FSO	-25...+85 °C	¼ BSP
50.0 bar	100.0 bar	0.01 bar		TP704-50BGI		0.25 % FSO	-40...+125 °C	¼ BSP
					TP704-50BAI	0.25 % FSO	-25...+85 °C	¼ BSP
100 bar	200 bar	0.1 bar		TP704-100BGI		0.25 % FSO	-40...+125 °C	¼ BSP
					TP704-100BAI	0.25 % FSO	-25...+85 °C	¼ BSP
200 bar	400 bar	0.1 bar		TP704-200BGI		0.25 % FSO	-40...+125 °C	¼ BSP
					TP704-200BAI	0.25 % FSO	-25...+85 °C	¼ BSP
500 bar	1000 bar	0.1 mbar		TP704-500BGI		0.25 % FSO	-40...+125 °C	¼ BSP
	700 bar	0.1 mbar			TP704-500BAI	0.25 % FSO	-25...+85 °C	¼ BSP

PP472 SICRAM probe for the measurement of barometric pressure

Measuring range	600...1100 mbar
Resolution	0.1 mbar
Accuracy @ 20 °C	±0.3 mbar
Operating temperature	-10...+60 °C

PP473 S0 SICRAM probe for the measurement of relative pressure with respect to the atmosphere or differential pressure in the range ± 250 Pa. The probe uses a silicon piezoresistive sensor with high accuracy and temperature compensation, which has excellent linearity, repeatability and stability over the time. A special **auto-zero** circuit periodically equalizes the differential pressure at the sensor input and corrects the offset; this feature makes the probe insensitive to the mounting position and compensates the sensor aging and the deviation of the zero with temperature changes, virtually eliminating maintenance operations. A typical application of the probe is clean rooms monitoring.

Measuring range	± 250 Pa (± 2.5 mbar)
Maximum overpressure	50 kPa
Resolution	0.1 Pa
Accuracy @ 25 °C	± (0.2 Pa + 1.5% of the measure)
Accuracy @ 0...50 °C	± (0.2 Pa + 3% of the measure)
Operating temperature	-10...+60 °C
Response time	0.125 s
Long-term stability	± 0.5% f.s. nominal (1000 h @ 25 °C)
Fluid in contact with the membrane	Non-corrosive dry gas or air
Connection	Ø 5 mm Tube

PP473 S1...PP473 S8

SICRAM probes for the measurement of differential pressure.

Measuring range	S1 =f.s. 10 mbar	S2 =f.s. 20 mbar	S3 =f.s. 50 mbar
	S4 =f.s. 100 mbar	S5 =f.s. 200 mbar	S6 =f.s. 500 mbar
	S7 =f.s. 1 bar	S8 =f.s. 2 bar	
Maximum overpressure	S1,S2,S3 =200 mbar	S4 =300 mbar	S5,S6 =1 bar
	S7 =3 bar	S8 =6 bar	
Accuracy @ 25 °C	S1,S2,S3 =0.5% f.s. S4 =0.25% f.s. S5,S6,S7,S8 =0.15% f.s.		

Operating temperature -10...+60 °C

Fluid in contact with the membrane non-corrosive dry gas or air

Connection Ø 5 mm Tube



Air speed

Air speed probes equipped with SICRAM module

	AP471 S1 AP471 S3	AP471 S2	AP471 S4
Type of measure	Wind speed, calculated flow rate, air temperature		
Type of sensor <i>Speed</i>	NTC thermistor	Omnidirectional NTC thermistor	
<i>Temperature</i>	NTC thermistor	NTC thermistor	
Measuring range			
<i>Speed</i>	0.1...40 m/s	0.1...5 m/s	
<i>Temperature</i>	-25...+80°C	-25...+80°C	0...80°C
Measurement resolution: <i>Speed</i>	0.01 m/s 0.1 km/h 1 ft/min 0.1 mph 0.1 knot		
<i>Temperature</i>	0.1°C		
Measurement accuracy: <i>Speed</i>	±0.2 m/s (0.10...0.99 m/s) ±0.4 m/s (1.00...9.99 m/s) ±0.8 m/s (10.00...40.00 m/s)	±0.05 m/s (0.10...0.99 m/s) ±0.15 m/s (1.00...5.00 m/s)	
<i>Temperature</i>	±0.8°C (-25...+80°C)		
Minimum speed	0.1 m/s		
Air temperature compensation	0...80°C		
Unit of Measurement <i>Speed</i> <i>Flow rate</i>	m/s – km/h – ft/min – mph – knot l/s - m³/s - m³/min - m³/h - ft³/s - ft³/min		
Pipeline section for flow rate calculation	0.0001...1.9999 m²		
Cable length	~2m		



Vane probes equipped with SICRAM module

	AP472 S1	AP472 S2
Type of measurements	Wind speed, calculated flow rate, air temperature	Wind speed, calculated flow rate
Diameter	100 mm	60 mm
Type of measurement <i>Speed</i> <i>Temperature</i>	Vane Tc K	Vane ----
Measuring range		
<i>Speed</i>	0.6...25 m/s	0.5...20 m/s
<i>Temperature</i>	-25...+80 °C (*)	-25...+80 °C (*)
Resolution		
<i>Speed</i>	0.01 m/s – 0.1 km/h - 1 ft/min – 0.1 mph – 0.1 knot	
<i>Temperature</i>	0.1 °C	----
Accuracy		
<i>Speed</i>	±(0.4 m/s + 1.5% f.s.)	±(0.4 m/s + 1.5% f.s.)
<i>Temperature</i>	±0.8 °C	----
Minimum speed	0.6 m/s	0.5 m/s
Units of measurement <i>Speed</i> <i>Flow Rate</i>	m/s – km/h – ft/min – mph – knot l/s - m³/s - m³/min - m³/h - ft³/s - ft³/min	
Pipeline section for flow rate calculation	0.0001...1.9999 m²	
Cable length	~2 m	

(*)The indicated value refers to the vane's working range.

SICRAM modules for Pitot tubes

	AP473 S1	AP473 S2	AP473 S3	AP473 S4
Type of measure	Air speed, calculated flow rate, differential pressure, air temperature			
Measuring range				
<i>Differential pressure</i>	10 mbar	20 mbar	50 mbar	100 mbar
<i>Air speed (*)</i>	2 ... 40 m/s	2 ... 55 m/s	2 ... 90 m/s	2 ... 130 m/s
<i>Temperature</i>	-200...+600 °C	-200...+600 °C	-200...+600 °C	-200...+600 °C
Resolution				
<i>Air speed</i>	0.1 m/s - 1 km/h - 1 ft/min - 1 mph - 1 knots			
<i>Temperature</i>	0.1°C			
Accuracy				
<i>Air speed</i>	±0.4% f.s. of pressure		±0.3% f.s. of pressure	
<i>Temperature</i>	±0.8 °C			
Minimum air speed	2 m/s			
Compensation of air temperature	-200...+600 °C (with K type thermocouple connected to the module)			
Measuring unit <i>Air speed</i> <i>Flow rate</i>	m/s – km/h – ft/min – mph - knots l/s – m³/s – m³/min – ft³/s – ft³/min			
Pipeline section for flow rate calculation	100...100000 cm² 0.01...10 m²			

(*) At 20 °C, 1013 mbar and negligible Ps (Static Pressure).

Photometry and Radiometry

LP471PHOT Probe for the measurement of illuminance , equipped with SICRAM module.				
Measuring range (lux)	0.10...199.99	...1999.9	...19999	...199.99x10 ³
Resolution (lux)	0.01	0.1	1	0.01 x 10 ³
Spectral range	In agreement with standard photopic curve V(λ)			
α (temperature coefficient) f ₆ (T)	<0.05% K			
Calibration uncertainty	<4%			
f ₁ (in agreement with photopic response V(λ))	<6%			
f ₂ (response according to cosine law)	<3%			
f ₃ (linearity)	<1%			
f ₄ (instrument reading error)	<0.5%			
f ₅ (fatigue)	<0.5%			
Class	B			
Drift after one year	<1%			
Working temperature	0...50 °C			
Reference standard	CIE n°69 – UNI 11142			



LP471LUM2 Probe for the measurement of luminance , equipped with SICRAM module.				
Measuring range (cd/m ²)	0.1...1999.9	...19999	...199.99x10 ³	...1999.9x10 ³
Resolution (cd/m ²)	0.1	1	0.01 x 10 ³	0.1 x 10 ³
Optical angle	2°			
Spectral range	In agreement with standard photopic curve V(λ)			
α (temperature coefficient) f ₆ (T)	<0.05% K			
Calibration uncertainty	<5%			
f ₁ (in agreement with photopic response V(λ))	<8%			
f ₃ (linearity)	<1%			
f ₄ (instrument reading error)	<0.5%			
f ₅ (fatigue)	<0.5%			
Class	C			
Drift after 1 year	<1%			
Working temperature	0...50 °C			
Reference standard	CIE n°69 – UNI 11142			

Typical response curve of the probes LP471PHOT and LP471LUM2:

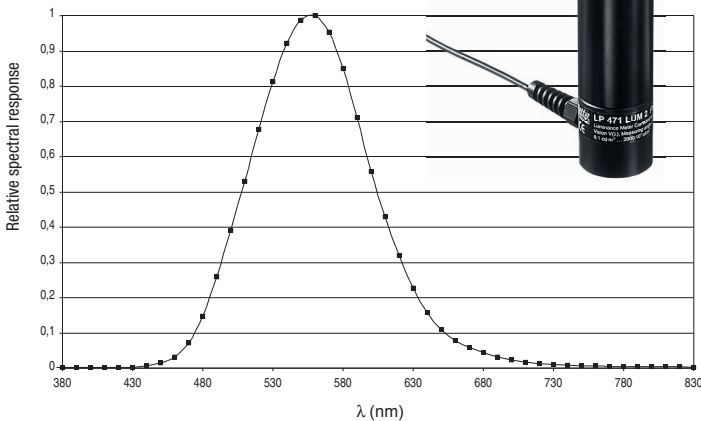

LP471PAR Quantum radiometric probe for the measurement of the photon flow across the chlorophyll range PAR , equipped with SICRAM module.			
Measuring range (μmol/m ² s)	0.01...199.99	200.0...1999.9	2000...10000
Resolution (μmol/m ² s)	0.01	0.1	1
Spectral range	400 nm...700 nm		
Calibration uncertainty	<5%		
f ₂ (response according to cosine law)	<6%		
f ₃ (linearity)	<1%		
f ₄ (instrument reading error)	±1 digit		
f ₅ (fatigue)	<0.5%		
Drift after one year	<1%		
Working temperature	0...50 °C		

Typical response curve of the probe LP471PAR:

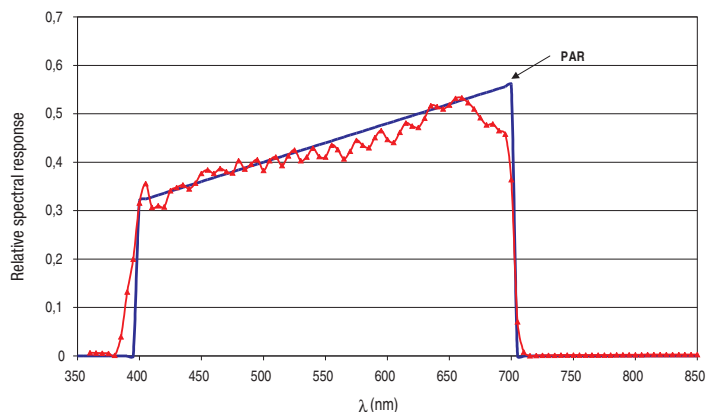

LP471RAD Probe for the measurement of irradiance, equipped with SICRAM module.				
Measuring range (W/m ²)	0.1x10 ⁻³ ...999.9x10 ⁻³	1.000...19.999	20.00...199.99	200.0...1999.9
Resolution (W/m ²)	0.1x10 ⁻³	0.001	0.01	0.1
Spectral range	400 nm...1050 nm			
Calibration uncertainty	<5%			
f ₂ (response according to cosine law)	<6%			
f ₃ (linearity)	<1%			
f ₄ (instrument reading error)	±1 digit			
f ₅ (fatigue)	<0.5%			
Drift after one year	<1%			
Working temperature	0...50 °C			

Typical response curve of the probe LP471RAD:

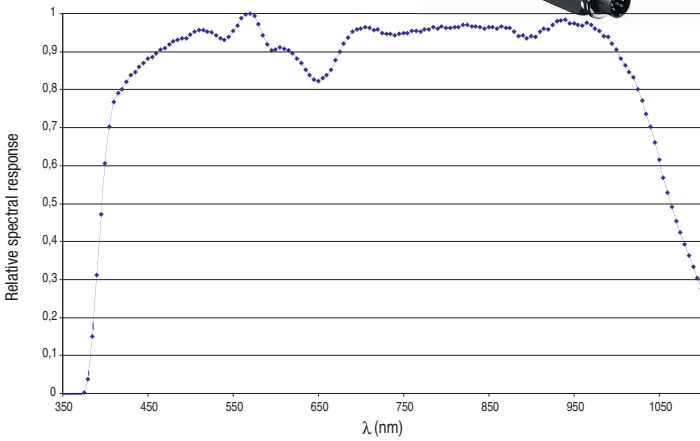

LP471UVB Probe for the measurement of the UVB irradiance, equipped with SICRAM module.				
Measuring range (W/m ²)	1x10 ⁻³ ...999.9x10 ⁻³	1.000...19.999	20.00...199.99	200.0...1999.9
Resolution (W/m ²)	0.1x10 ⁻³	0.001	0.01	0.1
Spectral range	280 nm...315 nm (Peak 305 nm)			
Calibration uncertainty	<5%			
f ₂ response according to cosine law	<6%			
f ₃ (linearity)	<2%			
f ₄ (instrument reading error)	±1 digit			
f ₅ (fatigue)	<0.5%			
Drift after one year	<2%			
Working temperature	0...50 °C			

Typical response curve of the probe LP471UVB:

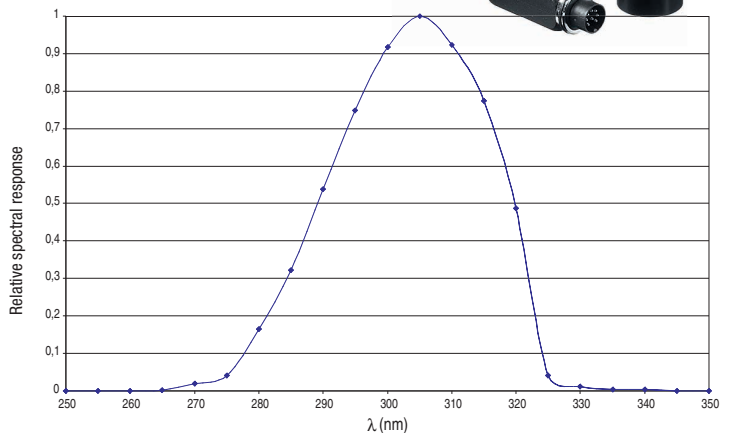

LP471UVA Probe for the measurement of UVA irradiance, equipped with SICRAM module.				
Measuring range (W/m ²)	1x10 ⁻³ ...999.9x10 ⁻³	1.000...19.999	20.00...199.99	200.0...1999.9
Resolution (W/m ²)	0.1x10 ⁻³	0.001	0.01	0.1
Spectral range	315 nm...400 nm (Peak 360 nm)			
Calibration uncertainty	<5%			
f ₂ (response according to cosine law)	<6%			
f ₃ (linearity)	<1%			
f ₄ (instrument measuring error)	±1 digit			
f ₅ (fatigue)	<0.5%			
Drift after one year	<2%			
Working temperature	0...50 °C			

Typical response curve of the probe LP471UVA:

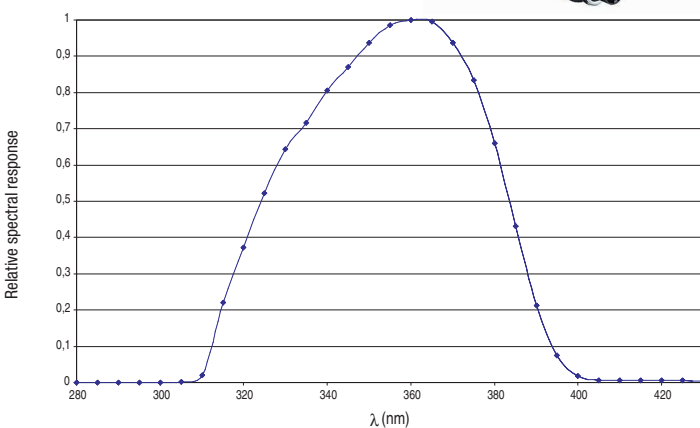

LP471UVC Probe for the measurement of the UVC irradiance, equipped with SICRAM module.				
Measuring range (W/m ²)	1x10 ⁻³ ...999.9x10 ⁻³	1.000...19.999	20.00...199.99	200.0...1999.9
Resolution (W/m ²)	0.1x10 ⁻³	0.001	0.01	0.1
Spectral range	220 nm...280 nm (Peak 260 nm)			
Calibration uncertainty	<5%			
f ₂ (response according to cosine law)	<6%			
f ₃ (linearity)	<1%			
f ₄ (instrument reading error)	±1 digit			
f ₅ (fatigue)	<0.5%			
Drift after one year	<2%			
Working temperature	0...50 °C			

Typical spectral response of the probe LP471UVC:

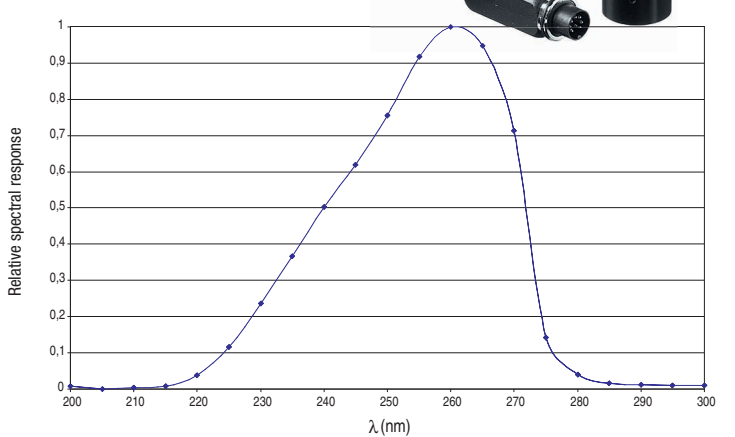

LP471BLUE Probe for the measurement of **effective irradiance in the blue light spectrum**, equipped with SICRAM module.

Measuring range (W/m ²)	0.1x10 ⁻³ ...999.9x10 ⁻³	1.000...19.999	20.00...199.99	200.0...1999.9
Resolution (W/m ²)	0.1x10 ⁻³	0.001	0.01	0.1
Spectral range	380 nm...550 nm. Effective irradiance for blue light hazard B(λ)			
Calibration uncertainty	<10%			
f ₂ (response according to cosine law)	<6%			
f ₃ (linearity)	<3%			
f ₄ (instrument reading error)	±1 digit			
f ₅ (fatigue)	<0.5%			
Drift after one year	<2%			
Working temperature	0...50 °C			

UVA irradiance				
Measuring range (μW/cm ²)	0.10...199.99	...1999.9	...19999	...199.99x10 ³
Resolution (μW/cm ²)	0.01	0.1	1	0.01x10 ³
Spectral range	315 nm...400 nm (Peak 360 nm)			
Calibration uncertainty	<5%			
f ₂ (response according to cosine law)	<6%			
f ₃ (linearity)	<1%			
f ₄ (instrument reading error)	±1 digit			
f ₅ (fatigue)	<0.5%			
Drift after one year	<2%			
Working temperature	0...50 °C			
Response curve	see response curve of the probe LP471UVA			

LP471A-Uveff Probe for the measurement of **total effective irradiance according to UV weighting curve**, equipped with SICRAM module.

Total effective irradiance	
Measuring range (W _{eff} /m ²)	0.010...19.999
Resolution (W _{eff} /m ²)	0.001
Spectral range	UV action curve for erythema measurement (250 nm...400 nm)
Calibration uncertainty	<15%
f ₃ (linearity)	<3%
f ₄ (instrument reading error)	±1 digit
f ₅ (fatigue)	<0.5%
Drift after one year	<2%
Working temperature	0...50 °C
Reference standard	CEI EN 60335-2-27
UVA irradiance	
Measuring range (W _{eff} /m ²)	0.1...1999.9
Resolution (W _{eff} /m ²)	0.1
Spectral range	315 nm...400 nm
UV-BC irradiance	
Measuring range (W _{eff} /m ²)	0.010...19.999
Resolution (W _{eff} /m ²)	0.001
Spectral range	250 nm...315 nm

Typical response curve of the probe LP471BLUE:

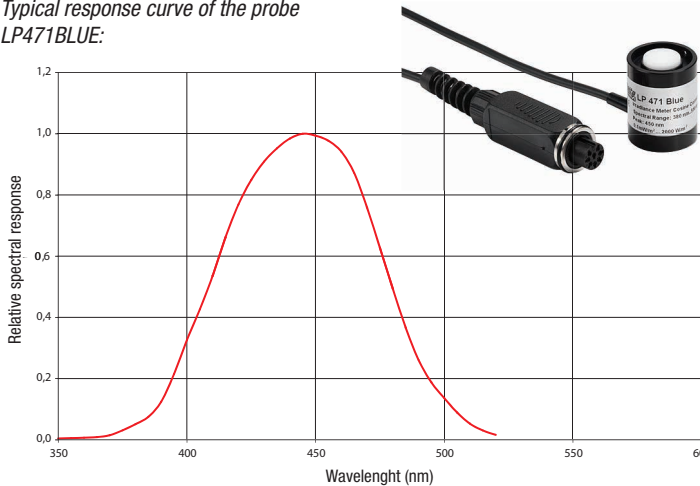

The radiometric probe LP 471 BLUE measures the irradiance (W/m²) in the spectral range of Blue light. The probe consists of a photodiode with an appropriate filter and is provided with a diffuser for correct measurement according to the cosine law. The spectral response curve of the probe allows measuring the effective irradiance for blue light hazard (curve B (λ)) according to the standards ACGIH/ICNIRP) in the spectral range from 380 nm to 550 nm. Optical radiations in this range can produce photochemical retinal injury. Another field of application is the monitoring of the blue light irradiance in the treatment of neonatal jaundice.

LP471P-A Two sensors combined probe for the measurement of **illuminance and UVA irradiance**, equipped with SICRAM module.

Illuminance				
Measuring range (lux)	0.3...199.99	...1999.9	...19999	...199.99x10 ³
Resolution (lux)	0.01	0.1	1	0.01x10 ³
Spectral range	In agreement with photopic standard curve V(λ)			
α (temperature coefficient) f ₆ (T)	<0.05% K			
Calibration uncertainty	<4%			
f ₁ (in agreement with photopic response V(λ))	<6%			
f ₂ (response according to cosine law)	<3%			
f ₃ (linearity)	<1%			
f ₄ (instrument reading error)	<0.5%			
f ₅ (fatigue)	<0.5%			
Class	B			
Drift after one year	<1%			
Working temperature	0...50 °C			
Reference standard	CIE n°69 – UNI 11142			
Response curve	see response curve of the probe LP471PH0T			

Typical response curve of the probe LP471A-Uveff:

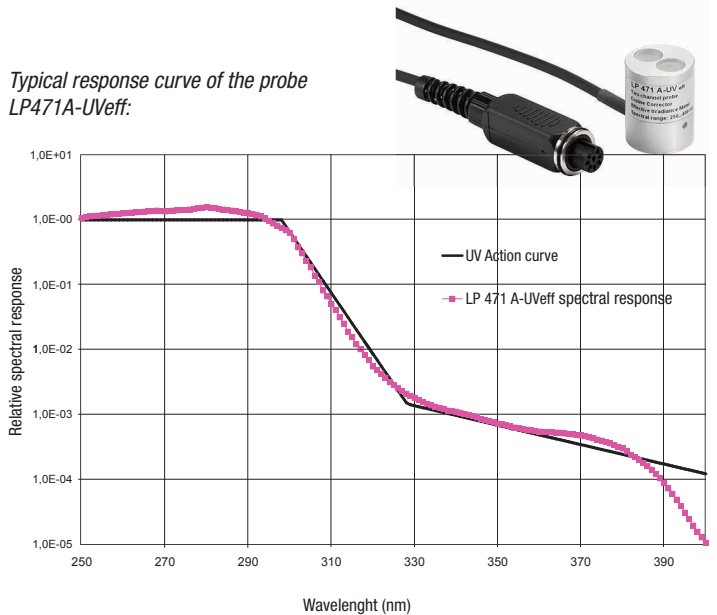

LP 471 PYRA 02.5
LP 471 PYRA 10.5

LP471 SILICON-PYRA Probe for the measurement of global solar irradiance , equipped with SICRAM module.				
Measuring range (W/m ²)	0.1x10 ⁻³ ... 999.9x10 ⁻³	1.000...19.999	20.00...199.99	200.0...1999.9
Resolution (W/m ²)	0.1x10 ⁻³	0.001	0.01	0.1
Spectral range	400 nm...1100 nm			
Calibration uncertainty	<3%			
f ₂ (response according to cosine law)	<3%			
f ₃ (linearity)	<1%			
f ₄ (instrument reading error)	±1 digit			
f ₅ (fatigue)	<0.5%			
Drift after 1 year	<2%			
Working temperature	0...50 °C			



Typical response curve of the probe LP471 SILICON-PYRA:

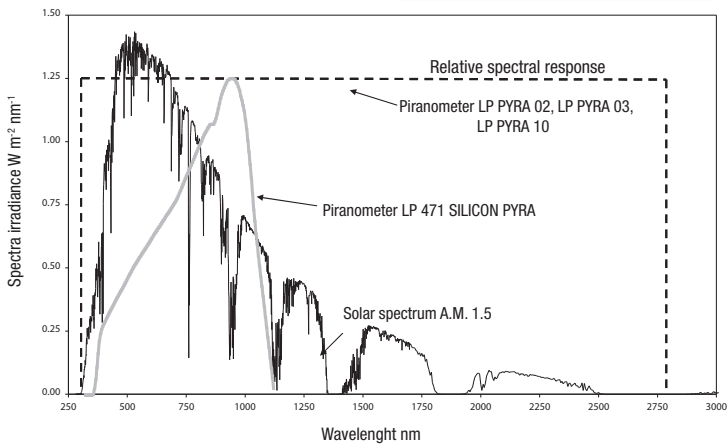

VP472 SICRAM module for the connection of pyranometers (e.g. “secondary-standard” LP PYRA 10, first class LP PYRA 02 and second class LP PYRA 03) or albedometers (e.g. first class LP PYRA 05 and second class LP PYRA 06).

Measuring range	-25...+25 mV
Resolution	1 W/m ² , 1 μV
Accuracy	±1 W/m ² , ±3 μV
Sensitivity	selectable from 5 to 30 μV/Wm ⁻²

CO₂ (carbon dioxide)

HD31.B3... Probe for CO₂ measurement, equipped with SICRAM module.

Sensor	Dual wavelength NDIR
Measuring range	0...5,000 ppm (HD31.B3) 0...10,000 ppm (HD31.B3-10)
Operating conditions	-20...60 °C / 0...95%RH non condensing
Accuracy @ 25 °C / 1013 mbar	±(50 ppm + 3% of measure) for HD31.B3 ±(100 ppm + 5% of measure) for HD31.B3-10
Resolution	1 ppm
Temperature dependence	1 ppm/°C
Response time (T ₉₀)	< 120 s (wind speed = 2 m/s)
Long-term stability	5% of measure / 5 years

ORDERING CODES

HD31 Handheld portable multifunction instrument and data logger instrument. Color graphic LCD. Three independent inputs for single channel or double channel combined probes or SICRAM modules. Records directly on SD memory card. USB port for PC connection or external power supply (optional). RS232C output for the connection to a serial printer. Supplied with: rechargeable Lithium battery, SD card, **software DeltaLog9** downloadable from Delta OHM website, instruction manual and carrying case.

Modules, probes, USB and serial connection cables, external power supply and rubber protection shell HD31.28 have to be ordered separately.

Accessories for HD31

CP31 PC connecting cable with male mini-USB connector on instrument side and male A type USB connector on PC side

CP31RS RS232C connecting cable for serial printer. RJ12 connector on instrument side and 9-pole female Sub-D connector on printer side.

SWD05 100-240 Vac / 5 Vdc - 1 A power adapter.

HD31.28 Protection shell in 55 shore rubber, with extractable back support. Colour dark grey.

HD35-BAT1 3.7 V lithium-ion **rechargeable** battery, capacity 2250 mA/h, 3-pole JST connector.

HD40.1 24-column portable thermal printer, serial interface, 57mm paper width, four NiMH 1.2V rechargeable batteries, SWD10 power supply, instruction manual, 5 thermal paper rolls.

BAT-40 Spare battery pack for HD40.1 printer with built-in temperature sensor.

RCT Four rolls of thermal paper, width 57mm, diameter 32mm.

Pt100 temperature probes equipped with SICRAM module

TP472I Immersion probe, Pt100 sensor. Stem \varnothing 3 mm, length 300 mm. Cable length 2 m.

TP472I.0 Immersion probe, Pt100 sensor. Stem \varnothing 3 mm, length 230 mm. Cable length 2 m.

TP473PI Penetration probe, Pt100 sensor. Stem \varnothing 4 mm, length 150 mm. Cable length 2 m.

TP473PO Penetration probe, Pt100 sensor. Stem \varnothing 4 mm, length 150 mm. Cable length 2 m.

TP474C.0 Contact probe, Pt100 sensor. Stem \varnothing 4 mm, length 230mm, contact surface \varnothing 5 mm. Cable length 2m.

TP475A.0 Air probe, Pt100 sensor. Stem \varnothing 4mm, length 230mm. Cable length 2 m.

TP472I.5 Immersion probe, Pt100 sensor. Stem \varnothing 6 mm, length 500 mm. Cable length 2 m.

TP472I.10 Immersion probe, Pt100 sensor. Stem \varnothing 6 mm, length 1,000 mm. Cable length 2 m.

TP49A.I Immersion probe, Pt100 sensor. Stem \varnothing 2.7 mm, length 150 mm. Cable length 2 m. Aluminium handle.

TP49AC.I Contact probe, Pt100 sensor. Stem \varnothing 4 mm, length 150 mm. Cable length 2 m. Aluminium handle.

TP49AP.I Penetration probe, Pt100 sensor. Stem \varnothing 2.7 mm, length 150 mm. Cable length 2 m. Aluminium handle.

TP875.I Globe thermometer \varnothing 150 mm with handle, complete with SICRAM module. Cable length 2 m.

TP876.I Globe thermometer \varnothing 50 mm with handle, complete with SICRAM module. Cable length 2m.

TP87.0 Immersion probe, Pt100 sensor. Stem \varnothing 3 mm, length 70 mm. Cable length 2 m.

TP878.0 Contact probe for solar panels. Cable length 2 m.

TP878.1.0 Contact probe for solar panels. Cable length 5 m.

TP879.0 Penetration probe for compost. Stem \varnothing 8 mm, length 1 m. Cable length 2 m.

Pt100 and Pt1000 temperature probes without SICRAM module

TP47.100.0 Direct 4 wires Pt100 sensor immersion probe. Probe's stem \varnothing 3mm, length 230 mm. Connection cable 4 wires with connector, length 2 m.

TP47.1000.0 Pt1000 sensor immersion probe. Probe's stem \varnothing 3 mm, length 230 mm. Connection cable 2 wires with connector, length 2 m.

TP87.100.0 Direct 4 wires Pt100 sensor immersion probe. Probe's stem \varnothing 3 mm, length 70 mm. Connection cable 4 wires with connector, length 2 m.

TP87.1000.0 Pt1000 sensor immersion probe. Probe's stem \varnothing 3 mm, length 70 mm. Connection cable 2 wires with connector, length 2 m.

Modules for NON SICRAM temperature probes

TP47 Module for the connection of **NO** SICRAM probes with Platinum sensor (PRT). Works with Pt25, Pt100 and Pt500 probes. Designed for the connection of 4-wire sensors.

TP471 Module for the connection of **NO** SICRAM probes with Platinum (PRT) sensor: Works with Pt25, Pt100 and Pt500 probes. Designed for the connection of 4-wire sensors.

TP471D0 1-input module for **NO** SICRAM thermocouple probes type K-J-E-T-N-R-S-B. **Without cold junction compensation.**

TP471D 1-input module for **NO** SICRAM thermocouple probes type K-J-E-T-N-R-S-B. **With internal temperature sensor for cold junction compensation.**

TP471D1 2-input module for **NO** SICRAM thermocouple probes type K-J-E-T-N-R-S-B. **With internal temperature sensor for cold junction compensation.**

Thermocouple temperature probes

TP741 Type K thermocouple immersion probe. Stem \varnothing 1.5 mm, length 180 mm. Maximum temperature 800 °C.

TP741/1 Type K thermocouple immersion probe. Stem \varnothing 1.5 mm, length 90 mm. Maximum temperature 400 °C.

TP741/2 Type K thermocouple immersion probe. Stem \varnothing 1.5 mm, length 230 mm. Maximum temperature 800 °C.

TP742 Type K thermocouple immersion probe. Stem \varnothing 2 mm, length 180 mm. Maximum temperature 800 °C.

TP742/1 Type K thermocouple immersion probe. Stem \varnothing 2 mm, length 90 mm. Maximum temperature 400 °C.

TP742/2 Type K thermocouple immersion probe. Stem \varnothing 2 mm, length 230 mm. Maximum temperature 800 °C.

TP743 Type K thermocouple immersion probe. Stem \varnothing 3 mm, length 180 mm. Maximum temperature 800 °C.

TP744 Type K thermocouple air probe. Stem \varnothing 4 mm, length 180 mm. Maximum temperature 400 °C.

TP745 Type K thermocouple contact probe. Probe terminal \varnothing 5 mm, stem length 180 mm Maximum temperature 500 °C.

TP746 Type K thermocouple contact probe. Stem \varnothing 12 mm. Probe terminal \varnothing 3 mm, stem length 110 mm. Maximum temperature 250 °C.

TP750 Type K thermocouple immersion probe. Stem \varnothing 3 mm, length 500 mm. Temperature -196...+1000 °C.

TP750.0 Type K thermocouple immersion probe. Stem \varnothing 3 mm, length 300 mm. Temperature -196...+800 °C.

TP751 Type K thermocouple penetration probe. Stem \varnothing 2 mm, length 25 mm. Maximum temperature 200 °C.

TP754 Type K thermocouple contact probe. Probe terminal \varnothing 15 mm, stem length 200 mm. Maximum temperature 500 °C.

TP754/9 Type K thermocouple contact probe. Probe terminal \varnothing 15 mm, stem length 200 mm. End bent at 90° with respect to the stem. Maximum temperature 500 °C.

TP755 Type K thermocouple contact probe. Probe terminal \varnothing 27 mm, stem length 300 mm. Maximum temperature 800 °C.

TP755/9 Type K thermocouple contact probe. Probe terminal \varnothing 27 mm, stem length 300 mm. End bent at 90° with respect to the stem. Maximum temperature 800 °C.

- PP473 S2** SICRAM probe for the measurement of differential pressure. Full scale 20 mbar. Operating temperature -10...+60 °C.
- PP473 S3** SICRAM probe for the measurement of differential pressure. Full scale 50 mbar. Operating temperature -10...+60 °C.
- PP473 S4** SICRAM probe for the measurement of differential pressure. Full scale 100 mbar. Operating temperature -10...+60 °C.
- PP473 S5** SICRAM probe for the measurement of differential pressure. Full scale 200 mbar. Operating temperature -10...+60 °C.
- PP473 S6** SICRAM probe for the measurement of differential pressure. Full scale 500 mbar. Operating temperature -10...+60 °C.
- PP473 S7** SICRAM probe for the measurement of differential pressure. Full scale 1 bar. Operating temperature -10...+60 °C.
- PP473 S8** SICRAM probe for the measurement of differential pressure. Full scale 2 bar. Operating temperature -10...+60 °C.

Hot-wire probes equipped with SICRAM module for the measure of air speed

- AP471 S1** Hot-wire telescopic probe, measuring range: 0.1...40m/s. Cable length 2 m.
- AP471 S2** Omnidirectional hot-wire probe, measuring range: 0.1...5m/s. Cable length 2 m.
- AP471 S3** Hot-wire telescopic probe with terminal tip for easy position, measuring range: 0.1...40m/s. Cable length 2 m.
- AP471 S4** Omnidirectional hot-wire telescopic probe with base, measuring range: 0.1...5m/s. Cable length 2 m.

Vane probes equipped with SICRAM module for the measure of air speed

- AP472 S1** Vane probe with K type thermocouple, Ø100 mm. Measuring range 0,6...25 m/s; temperature from -25 to 80 °C. Cable length 2 m.
- AP472 S2** Vane probe, Ø 60 mm. Measuring range: 0.5...20 m/s. Cable 2 m.
- AST.1** Telescopic shaft (minimum length 210 mm, maximum length 870 mm) for AP472S1 and AP472S2 vane probes.
- AP471S1.23.6** Fixed extension shaft Ø 16 x 300 mm, M10 male thread on a side, female on the other. For vane probes AP472 S1 and AP472 S2
- AP471S1.23.7** Fixed extension shaft Ø 16 x 300 mm, M10 female thread on a side only. For vane probes AP472 S1, AP472 S2.

Modules for Pitot Tubes

- AP473 S1** SICRAM module for **Pitot tubes**. Differential pressure up to 10 mbar, air speed from 2 to 40 m/s. The Pitot tube has to be ordered separately.
- AP473 S2** SICRAM module for **Pitot tubes**. Differential pressure up to 20 mbar, air speed from 2 to 55 m/s. The Pitot tube has to be ordered separately.
- AP473 S3** SICRAM module for **Pitot tubes**. Differential pressure up to 50 mbar, air speed from 2 to 90 m/s. The Pitot tube has to be ordered separately.
- AP473 S4** SICRAM module for **Pitot tubes**. Differential pressure up to 100 mbar, air speed from 2 to 130m/s. The Pitot tube has to be ordered separately.
- PW:** Connection cable between AP473S... module and **Pitot tube**.

Lenght 2m.

Pitot tubes

Stainless steel Pitot tubes to measure air speed and temperature (only for models provided with K thermocouple). Equipped with silicon tube external Ø 6 mm, internal Ø 4 mm, length 2 m. **PW cable has to be ordered separately.**

Photometric and radiometric probes with sicram module

- IP471PHOT** Photometric probe equipped with SICRAM module for measuring illuminance, spectral response according to the standard photopic vision, diffuser for cosine correction. Measuring range: 0.1 lux...200x10³ lux.
- LP471RAD** Radiometric probe equipped with SICRAM module for measuring **irradiance** in the 400 nm...1050 nm spectral range, complete with diffuser for cosine correction. Measuring range: 0.1x10⁻³W/m²...2000 W/m².
- LP471PAR** Quantum radiometric probe equipped with SICRAM module for measuring photon flow across the chlorophyll range PAR (Photosynthetically Active Radiation 400 nm...700 nm) in µmol/m²s, with diffuser for cosine correction. Measuring range: 0.01 µmol/m²s...10x10³ µmol/m²s.
- LP471UVA** Radiometric probe equipped with SICRAM module for measuring **irradiance** in the 315 nm...400 nm UVA spectral

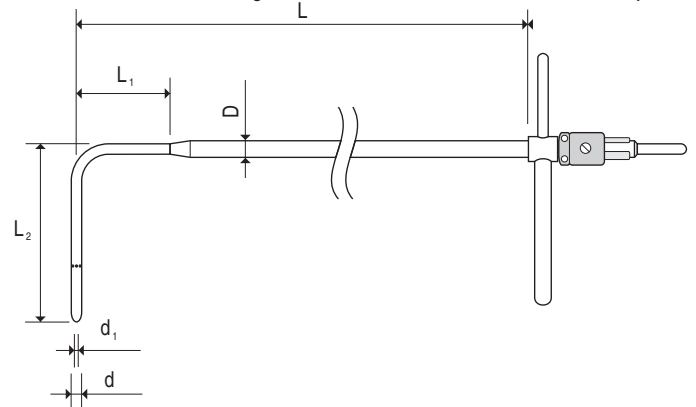

Code	d mm	d ₁ mm	D mm	L mm	L ₁ mm	L ₂ mm	Temp.	Thermo couple K	Material
T1-300	3	1	6	300	30	72	0...600 °C	---	AISI 316
T2-400	5	2	8	400	45	120		---	
T2-600	5	2	8	600	45	120		---	
T3-500	8	3,2	8	500	---	192		---	
T3-800	8	3,2	8	800	---	192		---	
T3-800TC	8	3,2	8	800	---	192		TC	
T4-500	10	4,0	10	500	---	240		---	
T4-800	10	4,0	10	800	---	240		---	
T4-800TC	10	4,0	10	800	---	240		TC	
T4-1000	10	4,0	10	1000	---	240		---	
T4-1000TC	10	4,0	10	1000	---	240	TC		



	range, peak 360 nm, complete with quartz diffuser for cosine correction. Measuring range: $1 \times 10^{-3} \text{ W/m}^2 \dots 2000 \text{ W/m}^2$.
LP471UVB	Radiometric probe equipped with SICRAM module for measuring irradiance in the 280 nm...315 nm UVB spectral range, peak 305 nm, complete with quartz diffuser for cosine correction. Measuring range: $1 \times 10^{-3} \text{ W/m}^2 \dots 2000 \text{ W/m}^2$.
LP471UVC	Radiometric probe equipped with SICRAM module for measuring irradiance in the 220 nm...280 nm UVC spectral range, peak 260 nm, complete with quartz diffuser for cosine correction. Measuring range: $1 \times 10^{-3} \text{ W/m}^2 \dots 2000 \text{ W/m}^2$.
LP471LUM2	Photometric probe equipped with SICRAM module for measuring luminance , spectral response in agreement with standard photopic vision, vision angle 2°. Measuring range: $0.1 \text{ cd/m}^2 \dots 2000 \times 10^3 \text{ cd/m}^2$.
LP471BLUE	Radiometric probe equipped with SICRAM module for measuring the effective irradiance in the spectral range of Blue light. Spectral range 380 nm...550 nm, diffuser for cosine correction. Measuring range: $0.1 \times 10^{-3} \text{ W/m}^2 \dots 2000 \text{ W/m}^2$.
LP471P-A	Combined probe equipped with SICRAM module for measuring the illuminance (lux), with standard photopic spectral response, and the irradiance ($\mu\text{W/cm}^2$) in the UVA spectral range (315-400 nm, with peak at 365 nm). Both sensors are equipped with diffuser for the correction according to the cosine law. Illuminance measuring range: 0.3 lux...200x103 lux. Irradiance measuring range: $1 \text{ mW/m}^2 \dots 2000 \text{ W/m}^2$. The probe provides the ratio of the UVA irradiance and the illuminance in $\mu\text{W/lumen}$ (quantity of interest in the museums field). Supplied with 2 m cable.
LP471A-UVeff	Combined probe equipped with SICRAM module for measuring the total effective irradiance according to the weighting curve UV. The two sensors are used to correctly measure the total effective irradiance in the range 250-400 nm. Both sensors are equipped with diffuser for the correction according to the cosine law. The probe provides the total effective irradiance (E_{eff}), the effective irradiance in the range UV-CB and the UVA irradiance. Total effective irradiance measuring range: $0.01 \text{ W/m}^2 \dots 20 \text{ W/m}^2$. B_C effective irradiance measuring range: $0.01 \text{ W/m}^2 \dots 20 \text{ W/m}^2$. UVA irradiance measuring range: $0.1 \text{ W/m}^2 \dots 2000 \text{ W/m}^2$. Supplied with 2 m cable.
LP471Silicon-Pyra	Pyranometer with silicon photodiode equipped with SICRAM module for measuring the global solar irradiance , with diffuser for cosine correction. Spectral range: 400...1100 nm. Measuring range: $0 \dots 2000 \text{ W/m}^2$. Fixed cable 5m long.
LP 471 PYRA 02.5	Probe consisting of a first class pyranometer LP PYRA 02 and a 5 m long cable equipped with SICRAM module.
LP 471 PYRA 02.10	Probe consisting of a first class pyranometer LP PYRA 02 and a 10 m long cable equipped with SICRAM module.
LP 471 PYRA 03.5	Probe consisting of a second class pyranometer LP PYRA 03 and a 5 m long cable equipped with SICRAM module.
LP 471 PYRA 03.10	Probe consisting of a second class pyranometer LP PYRA 03 and a 10 m long cable equipped with SICRAM module.
LP BL	Base with leveling device for photo and radiometric probes (excluding LP471LUM2 and LP471PYRA...). It has to be assembled to the probe at our factory, before shipment.
LP BL3	Adjustable wall support for photometric and radiometric probes (excluding LP471LUM2 and LP471PYRA...).
VP472	SICRAM module for the connection of pyranometers or albedometers. Measuring range: $-25 \dots +25 \text{ mV}$.

Probes and accessories for CO₂ measurement

HD31.B3	CO ₂ probe with SICRAM module. Measuring range 0...5000 ppm. Operating conditions: $-20 \dots 60 \text{ }^\circ\text{C} / 0 \dots 95\% \text{RH}$ non condensing.
HD31.B3-10	CO ₂ probe with SICRAM module. Measuring range 0...10,000 ppm. Operating conditions: $-20 \dots 60 \text{ }^\circ\text{C} / 0 \dots 95\% \text{RH}$ non condensing.
HD31.B3A	Adapter for the calibration of the CO ₂ sensor of the HD31.B3 probe

with the nitrogen can.

MINICAN.12A	Nitrogen can for CO ₂ calibration at 0 ppm. 20 litres volume. With regulating valve.
MINICAN.12A1	Nitrogen can for CO ₂ calibration at 0 ppm. 20 litres volume. Without regulating valve.
HD37.37	Connection tube kit between instrument and MINICAN.12A for CO ₂ calibration.

Modules for direct voltage and current measurement

VP473	SICRAM module for the measurement of direct voltage. When connected to a transmitter with voltage output, it can acquire the voltage signal. Measuring range: $\pm 20 \text{ Vdc}$. Input impedance: $1 \text{ M}\Omega$.
IP472	SICRAM module for the measurement of direct current. When connected to a transmitter with current output, it can acquire the current signal. Measuring range: $0 \dots 24 \text{ mA}$. Input impedance: $25 \text{ }\Omega$.